

6000LBS Steel cable

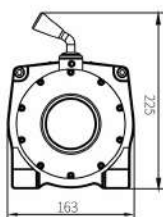
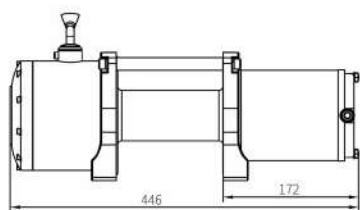
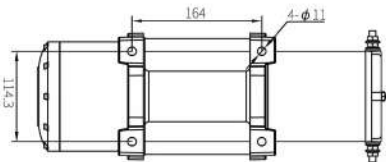

Specifications Winch Specification:

Rated Line Pull: 6000LB(2721kg) single-line
 Motor: 4.4hp/3.3kw 12V, Series Wound motor
 Gear Train: 3-stage planetary
 Gear Reduction Ratio: 265:1
 Clutch: Up and down 90°
 Cable φ8mm×15m
 Drum Size: φ2.51"×5.27"(φ64mm×134mm)
 Overall Dimensions: (L×W×H)17.0"×6.4"×6.7"(432mm×162mm×170mm)
 Gross Weight: 56 lbs(25.0kg)
 Duty Cycle: Intermittently
 Fairlead: 4-way roller fairlead
 Package: 1pc/box, 600xx245x370mm
 Mounting Bolt Pattern: 6.45"×4.5"(164mm×114.3)
 Remote Control: Included

Product Description Whole set winch including:

1x winch body with steel cable
 1x hook with safe strap
 1x 4-way roller fairlead
 1x control box set
 1x wired control
 1x wireless remote control
 1x black battery wire
 1x hardware bag
 1x manual book

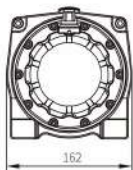
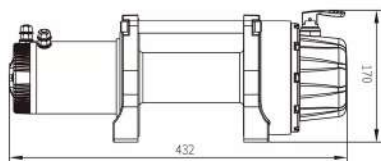
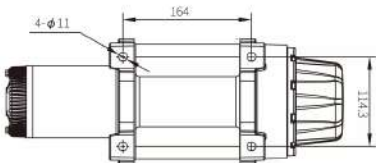

6000LBS Synthetic rope

Specifications Winch Specification:

Rated Line Pull: 6000LB(2721kg) single-line
 Motor: 4.4hp/3.3kw 12V, Series Wound motor
 Gear Train: 3-stage planetary
 Gear Reduction Ratio: 150:1
 Clutch: Up and down 90°
 Synthetic Rope: φ8mm×15m
 Drum Size: φ2.51"×5.27"(φ64mm×134mm)
 Overall Dimensions: (L×W×H)17.0"×6.4"×6.7"(432mm×162mm×170mm)
 Gross Weight: 53 lbs(24.0kg)
 Duty Cycle: Intermittently
 Fairlead: aluminium fairlead
 Package: 1pc/box, 600xx245x370mm
 Mounting Bolt Pattern: 6.45"×4.5"(164mm×114.3)
 Remote Control: Included

Product Description Whole set winch including:

1x winch body with synthetic rope
 1x hook with safe strap
 1x aluminium hawse fairlead
 1x control box set
 1x wired control
 1x wireless remote control
 1x black battery wire
 1x hardware bag
 1x manual book



9500LBS Steel cable

Specifications Winch Specification:

Rated Line Pull: 9500LB(4309kg) single-line
 Motor: 6.0hp/4.5kw 12V, Series Wound motor
 Gear Train: 3-stage planetary
 Gear Reduction Ratio: 265:1
 Clutch: Up and down 90°
 Steel cable: $\phi 3/8" \times 92"$ ($\phi 9.5\text{mm} \times 27\text{m}$)
 Drum Size: $\phi 2.51" \times 8.82"$ ($\phi 64\text{mm} \times 224\text{mm}$)
 Overall Dimensions: (LxWxH)21.1"x6.4"x6.7"(535x162x170mm)
 Gross Weight: 59lbs(26.8kg)
 Duty Cycle: Intermittently
 Fairlead: 4-way roller fairlead
 Package: 1pc/box, 600x245x370mm
 Mounting Bolt Pattern: 10"x4.5"

Product Description Whole set winch including:

1x winch body with steel cable
 1x hook with safe strap
 1x 4-way roller fairlead
 1x control box set
 1x wired control
 1x wireless remote control
 1x black battery wire
 1x hardware bag
 1x manual book

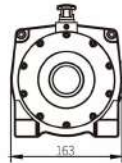
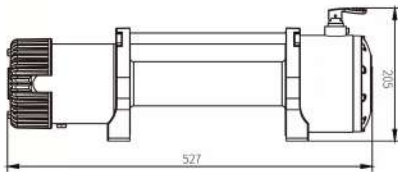
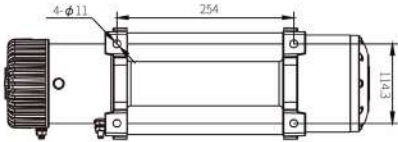

9500LBS Synthetic rope

Specifications Winch Specification:

Rated Line Pull: 9500LB(4309kg) single-line
 Motor: 6.0hp/4.5kw 12V, Series Wound motor
 Gear Train: 3-stage planetary
 Gear Reduction Ratio: 216:1
 Clutch: Up and down 90°
 Synthetic rope: $\phi 3/8" \times 92"$ ($\phi 9.5\text{mm} \times 27\text{m}$)
 Drum Size: $\phi 2.51" \times 8.82"$ ($\phi 64\text{mm} \times 224\text{mm}$)
 Overall Dimensions: (LxWxH)21.1"x6.4"x6.7"(535x162x170mm)
 Gross Weight: 59lbs(26.8kg)
 Duty Cycle: Intermittently
 Fairlead: aluminium hawse fairlead
 Package: 1pc/box, 600x245x370mm
 Mounting Bolt Pattern: 10"x4.5"

Product Description Whole set winch including:

1x winch body with synthetic rope
 1x hook with safe strap
 1x aluminium hawse fairlead
 1x control box set
 1x wired control
 1x wireless remote control
 1x black battery wire
 1x hardware bag
 1x manual book

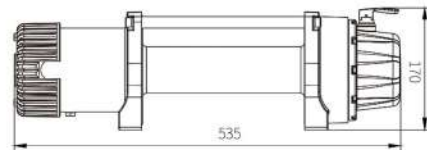
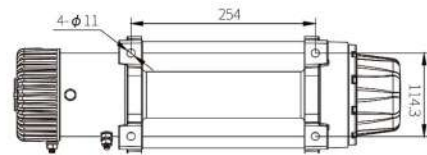

12000LBS Steel cable

Specifications Winch Specification:

Rated Line Pull: 12000LB(5443kg) single-line
 Motor: 6.0hp/4.5kw 12V, Series Wound motor
 Gear Train: 3-stage planetary
 Gear Reduction Ratio: 216:1
 Clutch: Up and down 90°
 Steel cable: $\phi 3/8" \times 92"$ ($\phi 9.5\text{mm} \times 27\text{m}$)
 Drum Size: $\phi 2.51" \times 8.82"$ ($\phi 64\text{mm} \times 224\text{mm}$)
 Overall Dimensions: (LxWxH)21.1"x6.4"x6.7"(535x162x170mm)
 Gross Weight: 59lbs(26.8kg)
 Duty Cycle: Intermittently
 Fairlead: 4-way roller fairlead
 Package: 1pc/box, 600x245x370mm
 Mounting Bolt Pattern: 10"x4.5"

Product Description Whole set winch including:

1x winch body with steel cable
 1x hook with safe strap
 1x 4-way roller fairlead
 1x control box set
 1x wired control
 1x wireless remote control
 1x black battery wire
 1x hardware bag
 1x manual book

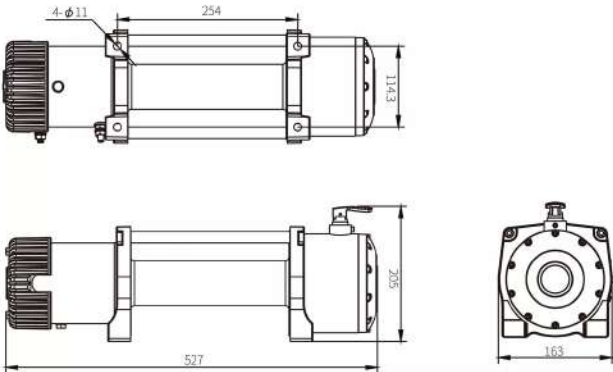

12000LBS Synthetic rope

Specifications Winch Specification:

Rated Line Pull: 12000LB(5443kg) single-line
 Motor: 6.0hp/4.5kw 12V, Series Wound motor
 Gear Train: 3-stage planetary
 Gear Reduction Ratio: 216:1
 Clutch: Up and down 90°
 Synthetic Rope: $\phi 3/8" \times 92"$ ($\phi 9.5\text{mm} \times 27\text{m}$)
 Drum Size: $\phi 2.51" \times 8.82"$ ($\phi 64\text{mm} \times 224\text{mm}$)
 Overall Dimensions: (LxWxH)21.1"x6.4"x6.7"(535x162x170mm)
 Gross Weight: 59lbs(26.8kg)
 Duty Cycle: Intermittently
 Fairlead: aluminium fairlead
 Package: 1pc/box, 600x245x370mm
 Mounting Bolt Pattern: 10"x4.5"

Product Description Whole set winch including:

1x winch body with synthetic rope
 1x hook with safe strap
 1x aluminium fairlead
 1x control box set
 1x wired control
 1x wireless remote control
 1x black battery wire
 1x hardware bag
 1x manual book

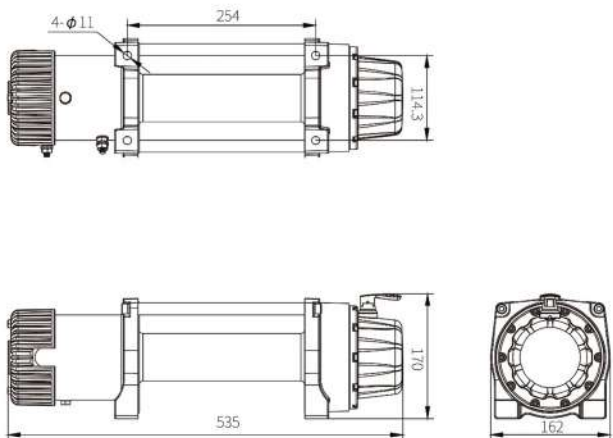

17000LBS Steel cable

Mounting Bolt Pattern

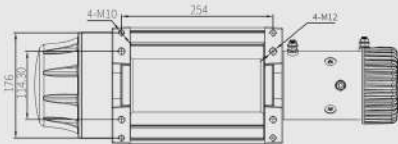

Dimensions

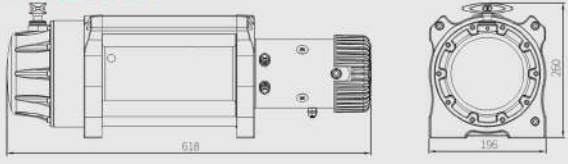

17000LBS Synthetic rope

Mounting Bolt Pattern



Dimensions

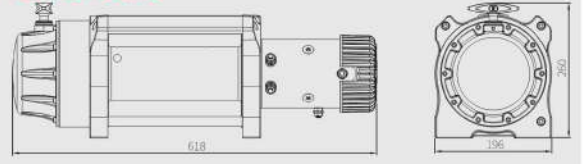

Product Description Truck winch heavy duty off road electric winch 17000lb Winch specification:

Rated Line Pull: 17000LB(7711kg) single-line
 Motor: 7.0hp/5.1kw 12V, Series Wound
 Gear Train: 3-stage planetary
 Gear Reduction Ratio: 364:1
 Clutch: turn 180°
 Cable: synthetic rope $\phi 7/16" \times 92"$ ($\phi 11\text{mm} \times 28\text{mm}$)
 Drum Size: $\phi 3.5" \times 8.82"$ ($\phi 89\text{mm} \times 224\text{mm}$)
 Overall Dimensions: (L×W×H) $22.3" \times 8.5" \times 9.7"$ ($567 \times 215 \times 246\text{mm}$)
 Gross Weight: 110lbs(50kg)
 Duty Cycle: Intermittently
 Fairlead: 4-way roller fairlead
 Package: 1pc/box, $25.7" \times 10.7" \times 16.2"$ ($650 \times 270 \times 410\text{mm}$)
 Mounting Bolt Pattern: $10" \times 4.5"$ ($254\text{mm} \times 114.3\text{mm}$)
 Remote Control: Included

Product Description Whole set winch including:

1x winch body with steel cable
 1x hook with safe strap
 1x 4-way roller fairlead
 1x control box set
 1x wired control
 1x wireless remote control
 1x black battery wire
 1x hardware bag
 1x manual book

Product Description Truck winch heavy duty off road electric winch 17000lb Winch specification:

Rated Line Pull: 17000LB(7711kg) single-line
 Motor: 7.0hp/5.1kw 12V, Series Wound motor
 Gear Train: 3-stage planetary
 Gear Reduction Ratio: 364:1
 Clutch: turn 180°
 Rope synthetic rope $\phi 11\text{mm} \times 30\text{m}$
 Drum Size: $\phi 3.5" \times 8.82"$ ($\phi 89\text{mm} \times 224\text{mm}$)
 Overall Dimensions: (L×W×H) $22.3" \times 8.5" \times 9.7"$ ($567 \times 215 \times 246\text{mm}$)
 Gross Weight: 110lbs(50kg)
 Duty Cycle: Intermittently
 Fairlead: 4-way roller fairlead
 Package: 1pc/box, $25.7" \times 10.7" \times 16.2"$ ($650 \times 270 \times 410\text{mm}$)
 Mounting Bolt Pattern: $10" \times 4.5"$ ($254\text{mm} \times 114.3\text{mm}$)
 Remote Control: Included

Product Description Whole set winch including:

1x winch body with synthetic rope
 1x hook with safe strap
 1x aluminium hawse fairlead
 1x control box set
 1x wired control
 1x wireless remote control
 1x black battery wire
 1x hardware bag
 1x manual book

